

**TIMELESS
TREASURES**



BROOME STREET PATTERNS

Row By Row™ Sew Musical

One Size Fits All Tote Bag

Designed by Linda Turner Griepentrog



Finished tote: 14" wide x 16" high x 4" deep

LEFT

Bag Body:
Row-C5935 Black

Lining/Inside Pocket:
Row-C5935 Blue

Outside Pocket:
Row-C5933 Cream

Outside Pocket Lining/Accent:
Row-C5933 Cream

Handles:
Row-C5937 Tan

CENTER

Bag Body:
Row-C5936 Sea

Lining/Inside Pocket:
Spin-C5300 Cream

Outside Pocket:
Row-C5938 Foam

Outside Pocket Lining/Accent:
Row-C5938 Foam

Handles:
Spin-C5300 Red

RIGHT

Bag Body:
Row-C5935 Red

Lining/Inside Pocket:
Spin-C5300 Aqua

Outside Pocket:
Row-C5934 Multi

Outside Pocket Lining/Accent:
Row-C5934 Multi

Handles:
Spin-C5300 Black

Row by Row™ Sew Musical fabrics designed by Debra Gabel of Zebra Patterns

Fabric Requirements

- 3/4 yard bag body (front and back)
- 3/4 yard bag lining/inside pocket
- 1/2 yard for outside pocket
- 1/2 yard for outside pocket lining/accent
- 5/8 yard for handles

Other Supplies

- 1 1/4 yards fusible fleece
- Pattern tracing paper
- Walking foot (optional)
- Quilting guide (optional)
- Removable fabric marker

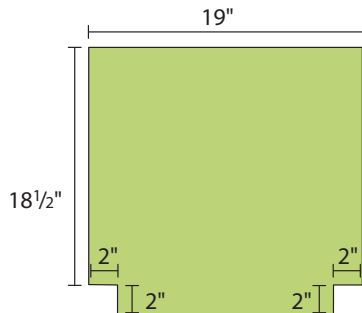

fig. 1-Bag Body

Cut 2 from fabric. Cut 2 from fleece.
Cut 2 from lining fabric, trimming
2 1/2" from upper edge.

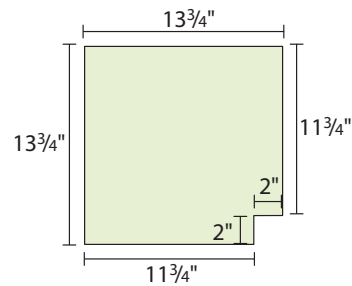

fig. 1-Outside Pocket

Cut 1 from fabric, right side up.
Cut 1 from fleece, adhesive side up.

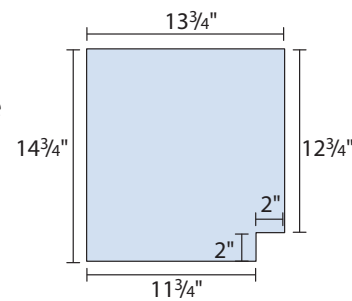

fig. 1-Outside Pocket Lining

Cut 1 from lining fabric, wrong
side up.

Cutting

Using figure 1 as a guide, draw the tote pattern pieces on pattern tracing paper and cut out.

From the bag-body fabric:

- Cut two bag-body pieces.

From the outside pocket fabric:

- Cut one outside pocket with the fabric *right* side up. If you have a one-way print, take note of the pocket direction. If the fabric is a stripe, cut with the stripes going crosswise.

From the outside pocket lining fabric:

- Cut one outside pocket lining piece with the fabric *wrong* side up.

From the bag lining fabric:

- Trim 2 1/2" from the bag-body pattern upper edge and cut two bag-body lining pieces.
- Cut one 6" x 7" rectangle for the inside pocket.

From the handle fabric:

- Cut four 3 3/4 x 30 1/2" strips.

From the fusible fleece:

- With the adhesive side up, cut two bag-body pieces, and one outside-pocket piece.
- Cut four 1 1/2" x 30" strips for handles.

Construction

Note: All seams are 1/2" unless otherwise noted.

Outside Pocket

1. Fuse the fleece to the outside pocket wrong side, following the manufacturer's instructions.
2. With right sides together, stitch the outside pocket to the outside pocket lining upper edge. Trim the seam to 1/4". *Note:* The lining is longer than the outside pocket.
3. Press the lining to the pocket inside, allowing 1/4" of the lining to show at the pocket upper edge as an accent. Baste the cut edges together, trimming the lining if needed at the lower edges. (figure 2)

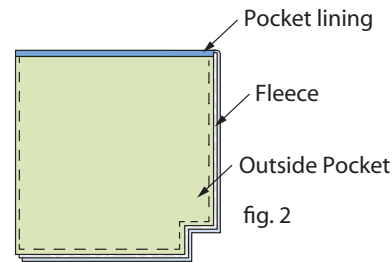

fig. 2

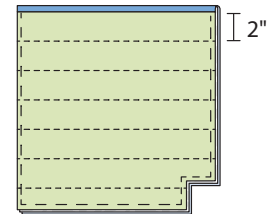

fig. 3

4. Use the fabric print as a guideline for quilting, or draw lines 2" apart across the outside pocket. Quilt the outside pocket on the lines. (figure 3) Set the pocket aside.

Bag Body

5. Fuse the fleece to the bag body front and back pieces.

6. Starting at the center and working outward, draw vertical lines 1 1/2" apart across the width of the bag front and back. Quilt on the lines. (figure 4)

Handles

7. Sew two handle pieces together end to end and press the seam allowances open. Repeat for the second handle.

8. Fuse the 1 1/2" x 30" fleece strips to the wrong side of the pieced handle strips, 1/4" from one long edge and abutting the ends together at the handle seam. Wrap the fabric tautly around the fleece and turn under both long fabric edges. Pin in place. Edgestitch both handle edges.

9. Mark the bag-body front and back centers and pin-mark a line 3 1/2" on each side of the center along the length of the bag. (figure 5)

10. Pin the handle in place on the bag body back with the inside edge along the marked line, matching the lower cut edges to the bag bottom edge. Be careful not to twist the handle. Mark a horizontal line 2" from the bag upper edge on each handle section. Edgestitch the handle in

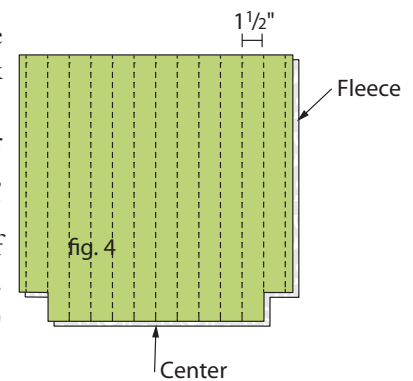

fig. 4

Center

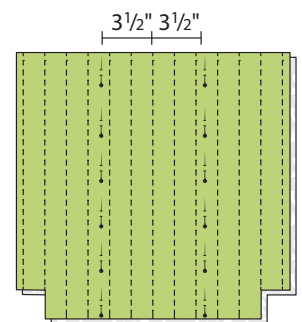

fig. 5

Center

place over the previous stitching line and across the horizontal marked line. Stitch twice across the handle width for reinforcement. (figure 6) Do NOT stitch the handle from the 2" mark to the top of the bag-body back.

11. Pin the right half of the second handle in place on the bag-body front panel and edgestitch in place as in step 10. Do not sew the left portion yet.

12. Place the quilted outside pocket over the right side of the bag body front, matching the side and lower edges. The pocket lining should be against the bag body front. Baste the edges in place. (figure 7) Pin-mark a line down the bag center on the outside pocket.

13. Position the remaining handle portion on the bag-body front, overlapping the left outside-pocket edge, and keeping the inside handle edge $3\frac{1}{2}$ " from the marked center line. Edgestitch the handle in place as in step 10, but position the horizontal stitching even with the upper outside-pocket edge. Do NOT stitch the handle to the bag from the top of the outside pocket to the top of the bag. (figure 8)

Bag Assembly

14. With right sides together, sew the bag-body front to the bag-body back at the sides and bottom. Press seams open.

15. To box the lower corners, fold one side seam exactly on top of the bottom seam and stitch across the edges. (figure 9) Repeat with the second side seam to create the second corner. Leave the bag wrong side out.

Bag Lining

16. To make the inside pocket, press under a double $\frac{1}{2}$ " hem at the long upper edge and $\frac{1}{2}$ " on each of the remaining three sides. Stitch the upper hem in place close to the lower fold.

17. Position the pocket on one lining section centered across the width and $3\frac{1}{2}$ " below the upper edge. Edgestitch the pocket in place, leaving the upper hemmed edge open. (figure 10)

18. Sew the bag lining seams as in steps 14 and 15, leaving a 6" opening in the bottom seam for turning. Turn the lining right side out.

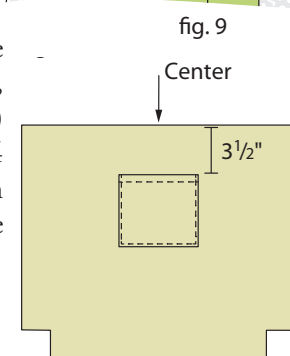
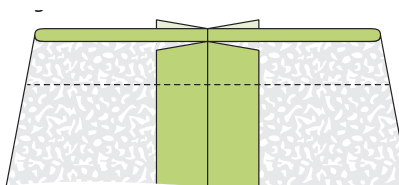
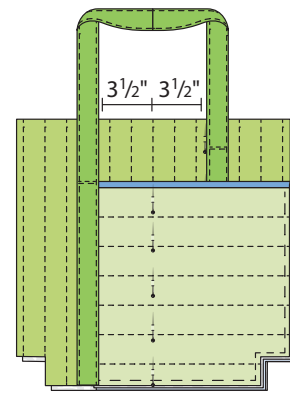
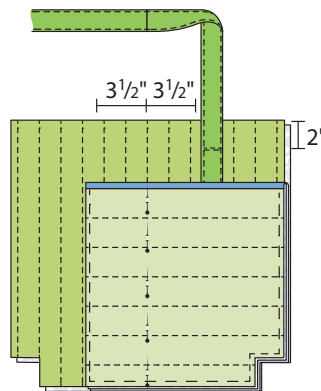
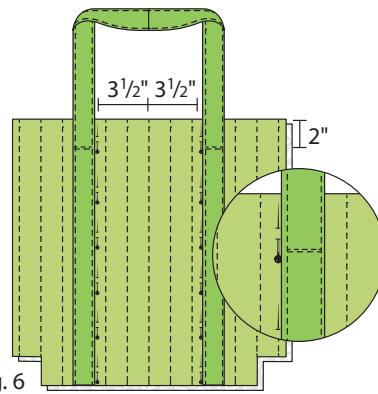

Finishing

19. With right sides together, slip the lining into the bag and pin the upper edges together, matching side seams and centers. The inside pocket can be placed either to the front or the back. Stitch around the bag opening, being careful not to catch the handles in the seam. (figure 11)

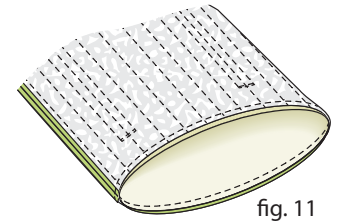

20. Turn the bag right side out through the lining opening. Press the lining/bag seam.

21. Stitch the lining opening closed by hand or machine, turning the raw edges to the inside.

22. Push the lining into the bag, turning under a $1\frac{1}{4}$ " bag hem at the upper edge. (figure 12)

23. Edgestitch around the upper bag, keeping handles free of the stitching.

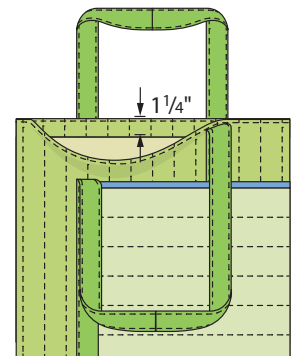

©2017 Timeless Treasures
 This pattern is for individual home use only.
 Permission is granted to shop owners and teachers to make copies for promotional or educational purposes only.
 This pattern may not be reproduced for commercial purposes (i.e., may not be sold).